



■ Features:

- Constant voltage output
- Protections: Short circuit / Over load
- Designed for indoor signage, decoration or lighting applications
- Small size, light weight, easy installation
- 100% full load burn-in test

SELV    

■ Specification:

MODEL		TLC-24E20	TLC-24E40	TLC-24E60	TLC-24E80	TLC-24E100
OUTPUT	DC Output	24V				
	Output Current	0.83A	1.67A	2.5A	3.33A	4.17A
	Voltage Tolerance	±5%				
	Rated Power	20W	40W	60W	80W	100W
	Ripple Noise	200mV P-P				
	Setup Rise Time	1000mS@220V				
INPUT	Input Voltage	220±10%Vac				
	Frequency Range	50/60Hz				
	Efficiency	80%	80%	80%	80%	80%
	AC Current	≤0.19A	≤0.38A	≤0.57A	≤0.77A	≤0.96A
	AC inrush current(max.)	65A@230VAC				
PROTECTION	Over Load	105%-120% rated power , Protection Type:auto-recovery ,after fault condition is removed				
	Short Circuit	Protection Type:recovery automatically after fault condition is removed				
ENVIRONMENT	Operating Temperature	-25°C ~ +40°C				
	Operating Humidity	5% ~ 95%				
	Storage Temperature	-35°C ~ +65°C				
SAFETY & EMC	EMC	EN 55015 : 2006+A2 : 2009 ; EN 61547 : 2009				
	Withstand Voltage	I/P-FG:1.5KV AC I/P-O/P:3.0KV AC				
OTHERS	Dimension(mm)	150*25*16	200*25*16	250*25*16	290*25*16	320*25*16
	Packing Dimension(mm)	300x220x210	300x220x210	300x270x210	310x300x210	340x300x210
	Packing Weight(Kg)	100PCS/11	100PCS/11	100PCS/14	100PCS/15.5	100PCS/16.5

■ Dimension:

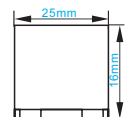
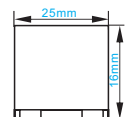
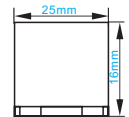
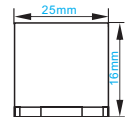
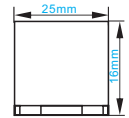

■ Wiring Diagram:

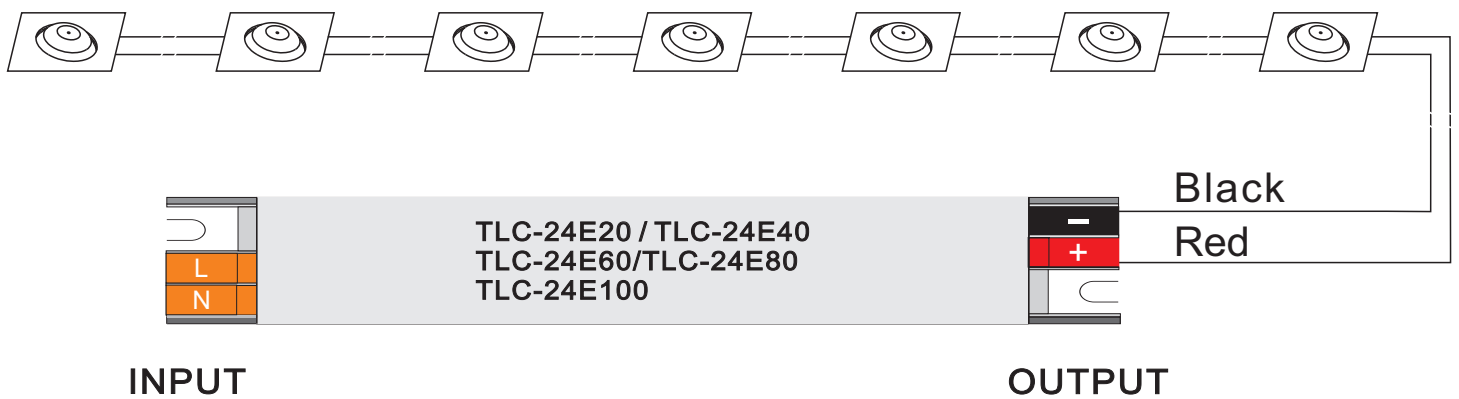

■ Derating Curve:

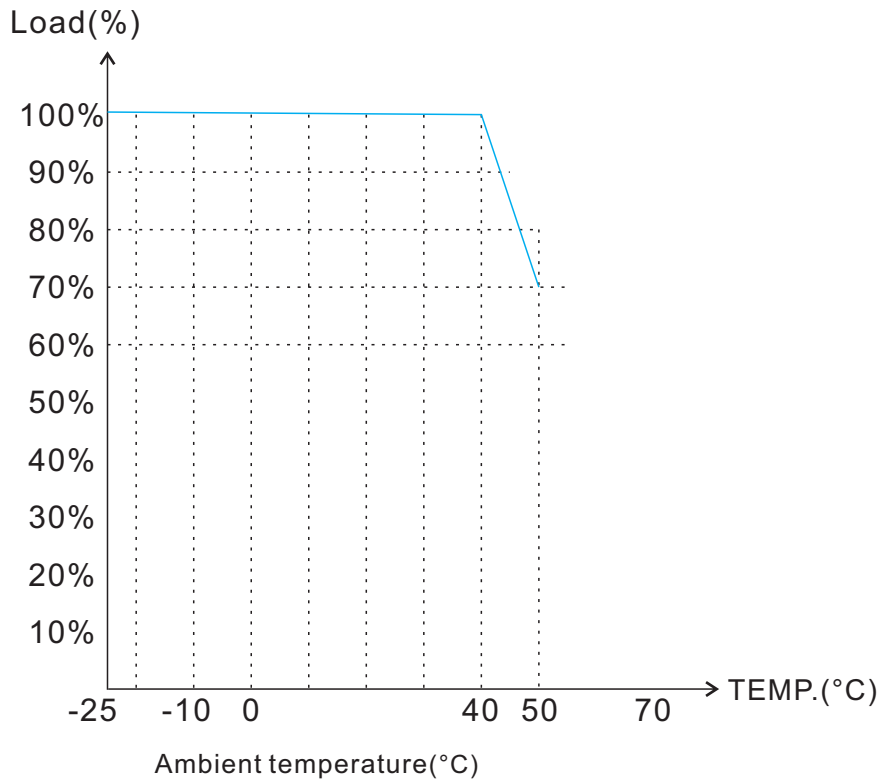

*NOTE: Start-up possible for 220VAC

■ Static Characteristic Curve:

