

- Mounting to drywall
- No collision with the ceiling structure
- Line of light flush with the surface
- Non visible aluminum elements
- Small bending radius

### APPLICATION

- main and decorative lighting

### MOUNTING

- in drywall, with mounting adhesive

### ADDITIONAL INFORMATION

- in order to protect the lighting fixture during installation, a TECH-KA protective insert should be used
- when choosing a different length of profiles / covers than available in the standard, you should additionally choose the cutting service at KLUŚ

### TECHNICAL DRAWING

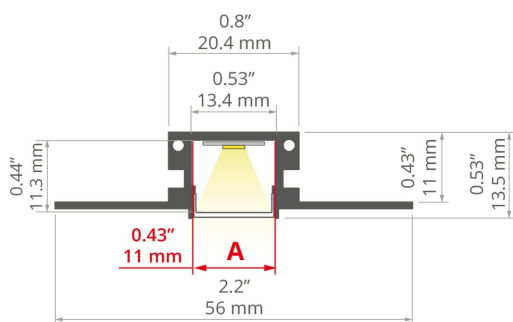

### TECHNICAL SPECIFICATIONS

Material	aluminum
Color	■ silver non anodized
Possible fixture IP	20, 67
Possible fixture shapes	linear, polygonal
Profile cross-section	rectangular
Width	2.2"
Height	0.5"
LED gluing width A	0.4"
Number of LED strips A (0.31" wide)	1
Width of the glow	11.2 mm
Max power of a single KLUŚ LED strip	7.3 W/ft
Possibility of obtaining a line of light	yes
Possibility of bending	yes
Radius of the light arc	yes
Inward	500 mm
Outdoor	500 mm

Length	Ref
39.4"	A18040N_1
78.9"	A18040N_2

Building type	Commercial, Retail, Residential, Hotel / Restaurant, Entertainment/ Arts
Facility zone	bathroom, lobby / foyer, office, decorative, media rooms / av
The cover is cut to the length of the profile	yes
Can be easily connected into runs	yes
Mounting to drywall	yes
To cover with plaster	yes
Wire out back of extrusion	yes

## LINE OF LIGHT TABLE

LED tape	LIGER-11 satin	LIGER-11 black	HS-11 frosted	KA-11 frosted	KA frosted
K-2400-24	✓ (1)	X	✓ (1)	✓ (1)	✓ (1)
KWP-GDL-1229-24	✓ (1)	X	X	✓ (1)	✓ (1)
K-CR-1220-24	✓ (1)	X	X	✓ (1)	✓ (1)
K-CR-1275-24	✓ (1)	X	X	✓ (1)	✓ (1)
K-CRHD-1820-24	✓ (1)	✓ (1)	✓ (1)	✓ (1)	✓ (1)
K-CRHD-1910-24	✓ (1)	✓ (1)	✓ (1)	✓ (1)	✓ (1)
K-HEHD-0480-24	✓ (1)	X	✓ (1)	✓ (1)	✓ (1)
K-HEHD-0960-24	✓ (1)	X	✓ (1)	✓ (1)	✓ (1)
K-HEHD-1440-24	✓ (1)	X	✓ (1)	✓ (1)	✓ (1)
K-HEHD-1920-24	✓ (1)	X	✓ (1)	✓ (1)	✓ (1)
K-HEHD-0320-24	✓ (1)	X	✓ (1)	✓ (1)	✓ (1)
K-RGBW-1920-120-24	✓ (1)	X	X	✓ (1)	✓ (1)
K-RGB-0700-24V	✓ (1)	X	X	✓ (1)	✓ (1)
KWP-RGB-1200-24	✓ (1)	X	X	✓ (1)	✓ (1)
K-18D30-0960-24	✓ (1)	✓ (1)	✓ (1)	✓ (1)	✓ (1)
K-27T50-1440-24	✓ (1)	✓ (1)	✓ (1)	✓ (1)	✓ (1)
K-CRHD-0530-24	✓ (1)	✓ (1)	✓ (1)	✓ (1)	✓ (1)
K-30/18-1770-010V-24V	✓ (1)	✓ (1)	✓ (1)	✓ (1)	✓ (1)
K-HEHD-1440-24-40C	✓ (1)	X	✓ (1)	✓ (1)	✓ (1)
KWP-GRGBW-1920-120-24	✓ (1)	X	X	✓ (1)	✓ (1)

### Description

✓ - Line of Light for a number (X) of rows - Pixel free imaging

X - Visible Dotting from Diodes

HL - Centered Line of Light - Concentrated in middle

HL (X) - Centered Line of Light for a number (X) of rows - Concentrated in middle

## Line of Light Guide



Clean Line of Light (Pixel free imaging)



Centered Line of Light



Visible Dotting from Diodes

## SAMPLE PROJECTS



## SIMILAR EXTRUSIONS > SUSPENDED



**PDS-ZM Extrusion**  
A07696

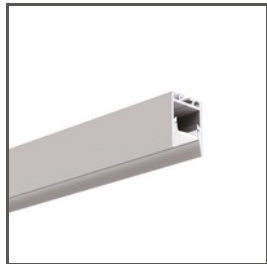

**PDS-ZMG Extrusion**  
A01418

## SIMILAR EXTRUSIONS > SURFACE MOUNTED



**PDS-H Extrusion**  
A09204

## SIMILAR EXTRUSIONS



**PDS-NK Extrusion**  
A01588

## SIMILAR EXTRUSIONS > TRIMLESS



**PDS-UST Extrusion**  
A02725







**PDS-T Extrusion**  
A02057

## SIMILAR EXTRUSIONS > RECESSED WITH SUSPENSION FUNCTION



**PDS-ZM-PLUS Extrusion**  
A02056

## RELATED ACCESSORIES > COVERS

NAME	KEY FEATURES	MATERIAL	MATERIAL TRANSMITTANCE	COLOR	REF.
Cover BENCO-11 <span style="background-color: red; color: white; padding: 2px;">NEW</span>	 - For indoor and outdoor applications - UV resistant	silicon	50 %	frosted	B17215F
LIGER-11 Cover	 - indoor use - Ease of obtaining a line of light - perfectly diffusing - high light quality	PC	21 % 59 %	black satin	B17037B B17037S
LENSO-11 30°DEG Focusing cover	 - indoor use - focusing	PC	80 %	semi-transparent	B17112T
HS-11 Cover	 - For indoor and outdoor applications - UV resistant - high durability	PC	59 % 88 %	frosted clear	B17208F B17208C
KA-11 Cover	 - maximum brightness - indoor use - basic - universal	PC	67 % 89 %	frosted clear	B17064F B17064C

## RELATED ACCESSORIES > END CAPS

NAME	MATERIAL	COLOR	REF.
KOZMA End cap 	PP	<span style="display: inline-block; width: 10px; height: 10px; background-color: gray; border: 1px solid gray;"></span> gray	C24217C02

## RELATED ACCESSORIES > RELATED LED > RGB / RGB-W / RGB-CTT

Name	Key features	IP protection rating	Power consumption	Ref.
KWP-RGB-1920-24 LED tape	- RGB	65	5.9 W/ft	KWP-RGB-1920-24
K-RGBW-1920-120-24 LED tape	- RGBW (3000K)	20	5.9 W/ft	K-RGBW-1920-120-24
K-RGBW-1920-160-24 LED tape	- RGBW (3000K)	20	5.9 W/ft	K-RGBW-1920-160-24
KWP-GRGBW-1920-120-24 LED tape	- RGBW (3000K)	65	5.9 W/ft	KWP-GRGBW-1920-120-24

## RELATED ACCESSORIES > RELATED LED > HIGH EFFICACY

Name	Key features	IP protection rating	Power consumption	Ref.
K-HEHD-0480-24 LED tape	- CRI over 95 - High Efficacy	20	1.5 W/ft	K-HEHD22-0480-24 K-HEHD25-0480-24 K-HEHD27-0480-24 K-HEHD30-0480-24 K-HEHD35-0480-24 K-HEHD40-0480-24 K-HEHD50-0480-24

Name	Key features	IP protection rating	Power consumption	Ref.
K-HEHD-0960-24 LED tape	- CRI over 95 - High Efficacy	20	2.9 W/ft	K-HEHD22-0960-24 K-HEHD25-0960-24 K-HEHD27-0960-24 K-HEHD30-0960-24 K-HEHD35-0960-24 K-HEHD40-0960-24 K-HEHD50-0960-24
K-HEHD-1440-24 LED tape	- CRI over 95 - High Efficacy	20	4.4 W/ft	K-HEHD22-1440-24 K-HEHD25-1440-24 K-HEHD27-1440-24 K-HEHD30-1440-24 K-HEHD35-1440-24 K-HEHD40-1440-24 K-HEHD50-1440-24
LED tape K-HEHD-1920-24	- CRI over 95 - High Efficacy	20	5.9 W/ft	K-HEHD22-1920-24 K-HEHD25-1920-24 K-HEHD27-1920-24 K-HEHD30-1920-24 K-HEHD35-1920-24 K-HEHD40-1920-24 K-HEHD50-1920-24
K-HEHD-0320-24 LED tape	- CRI over 95 - High Efficacy	20	1 W/ft	K-HEHD22-0320-24 K-HEHD25-0320-24 K-HEHD27-0320-24 K-HEHD30-0320-24 K-HEHD35-0320-24 K-HEHD40-0320-24 K-HEHD50-0320-24

## RELATED ACCESSORIES > RELATED LED > CRI 95+

Name	Key features	IP protection rating	Power consumption	Ref.
LED tape K-CR-1210-24	- CRI over 95	20	1.5 W/ft	K-CR22-1210-24 K-CR25-1210-24 K-CR27-1210-24 K-CR30-1210-24 K-CR35-1210-24 K-CR40-1210-24 K-CR50-1210-24
LED tape K-CR-1220-24	- CRI over 95	20	2.9 W/ft	K-CR22-1220-24 K-CR25-1220-24 K-CR27-1220-24 K-CR30-1220-24 K-CR35-1220-24 K-CR40-1220-24 K-CR50-1220-24
LED tape K-CR-1275-24	- CRI over 95	20	4.4 W/ft	K-CR22-1275-24 K-CR25-1275-24 K-CR27-1275-24 K-CR30-1275-24 K-CR35-1275-24 K-CR40-1275-24 K-CR50-1275-24
K-CRHD-1820-24 LED tape	- CRI over 95 - high LED density	20	5.6 W/ft	K-CRHD22-1820-24 K-CRHD25-1820-24 K-CRHD27-1820-24 K-CRHD30-1820-24 K-CRHD35-1820-24 K-CRHD40-1820-24 K-CRHD50-1820-24

Name	Key features	IP protection rating	Power consumption	Ref.
K-CRHD-1910-24 LED tape	- CRI over 95 - high LED density	20	2.8 W/ft	K-CRHD22-1910-24 K-CRHD25-1910-24 K-CRHD27-1910-24 K-CRHD30-1910-24 K-CRHD35-1910-24 K-CRHD40-1910-24 K-CRHD50-1910-24
KWP-CR-1220-24 LED tape	- CRI over 95	65	2.9 W/ft	KWP-CR22-1220-24 KWP-CR25-1220-24 KWP-CR27-1220-24 KWP-CR30-1220-24 KWP-CR35-1220-24 KWP-CR40-1220-24 KWP-CR50-1220-24
KWP-CR-1275-24 LED tape	- CRI over 95	65	4.4 W/ft	KWP-CR22-1275-24 KWP-CR25-1275-24 KWP-CR27-1275-24 KWP-CR30-1275-24 KWP-CR35-1275-24 KWP-CR40-1275-24 KWP-CR50-1275-24
K-HEHD-1440-24-40C LED tape	- High Efficacy - cold weather -40F	20	4.4 W/ft	K-HEHD22-1440-24-40C K-HEHD25-1440-24-40C K-HEHD27-1440-24-40C K-HEHD30-1440-24-40C K-HEHD35-1440-24-40C K-HEHD40-1440-24-40C K-HEHD50-1440-24-40C
K-CRHD-0530-24 LED tape,	- CRI over 95	20	1.6 W/ft	K-CRHD22-0530-24 K-CRHD25-0530-24 K-CRHD27-0530-24 K-CRHD30-0530-24 K-CRHD35-0530-24 K-CRHD40-0530-24 K-CRHD50-0530-24

## RELATED ACCESSORIES > RELATED LED > CRI 90+

Name	Key features	IP protection rating	Power consumption	Ref.
KWP-GHD-1640-24 LED tape	- high LED density	65	5 W/ft	KWP-GHD22-1640-24 KWP-GHD25-1640-24 KWP-GHD27-1640-24 KWP-GHD30-1640-24 KWP-GHD35-1640-24 KWP-GHD40-1640-24 KWP-GHD50-1640-24
KWP-GHD-1910-24 LED tape	- high LED density	65	2.8 W/ft	KWP-GHD22-1910-24 KWP-GHD25-1910-24 KWP-GHD27-1910-24 KWP-GHD30-1910-24 KWP-GHD35-1910-24 KWP-GHD40-1910-24 KWP-GHD50-1910-24
LED tape K-2400-24	- high power	20	7.3 W/ft	K-27-2400-24 K-30-2400-24 K-35-2400-24 K-40-2400-24 K-50-2400-24

## RELATED ACCESSORIES > RELATED LED > ADJUSTABLE WHITE / DIM TO WARM

Name	IP protection rating	Power consumption	Ref.

Name	IP protection rating	Power consumption	Ref.
LED tape K-30/18-1770-010V-24V	20	3.5 W/ft	K-30/18-1770-010V-24V
LED tape KWP-G30/18-1770-010-24	65	3.5 W/ft	KWP-G30/18-1770-010-24

## RELATED ACCESSORIES > RELATED LED

Name	Key features	IP protection rating	Power consumption	Ref.
LED tape K-18D30-0960-24	- Dim To Warm LED Stripe	20	2.9 W/ft	K-18D30-0960-24
LED tape K-27T50-1440-24	- RGB+Tunable White	20	4.4 W/ft	K-27T50-1440-24
LED tape KWP-RGB-1200-24	- RGB	65	3.7 W/ft	KWP-RGB-1200-24

## RELATED ACCESSORIES > RELATED LED > SINGLE DIODE PIXEL CONTROLLABLE

Name	Key features	IP protection rating	Power consumption	Ref.
Digital LED strip KWP-GDL-1229-24	- Digital tape	65	3.7 W/ft	KWP-GDL30-1229-24 KWP-GDL40-1229-24

## RELATED ACCESSORIES > OTHER ACCESSORIES > TECHNICAL AND PROTECTIVE INSERTS

Name	Key features	Material	Color	Ref.
TECH-KA Protective insert	- Protection of the fixture interior during installation	PVC	 gray satin	C24530C02_1 C24530C02_2 C24530C02_3

## RELATED ACCESSORIES > OTHER ACCESSORIES > ADDITIONAL ITEMS

Name	Key features	Material	Color	Ref.
LENZO Adapter	- Necessary when using the DILENSO cover	PC	 transparent glossy	E62146

## RELATED ACCESSORIES > OTHER ACCESSORIES > CONNECTORS

Name	Material	Color	Ref.
ZM Connector	stainless steel	 silver	42716 42717 42720 42728 C28070N00 C28071N00 C28072N00 C28073N00 C28074N00 C28075N00 C28243N00
ZM-NA Connector	stainless steel	 silver	42305 42339 42723 42724 42725 C28242N00

Name	Material	Color	Ref.
ZM-PION Connector	stainless steel	 silver	42314
			42316
			42320
			42718
			42719
			C28084N00
			C28085N00
			C28086N00
ZM-NA-PION Connector	stainless steel	 silver	42315
			42317
			42321
			42726
			42727

## RELATED ACCESSORIES > OTHER ACCESSORIES

Name	Key features	Material	Color	Ref.
Protective insert TECH-11 	- Protection of the fixture interior during installation	PVC	 gray colored	C24574C02_1 C24574C02_2 C24574C02_3

## RELATED ACCESSORIES > ELECTRONICS > SWITCHES

Name	Key features	IP protection rating	Ref.
Switch MICRO 96W IP20	- push button switch - factory pre-soldered wires	20	1576
Proximity switch UNI	- touchless switch - width only 7mm	20	E61579