

- Up/down lighting
- Smooth extrusions walls
- Fasteners are mounted to the cover hook
- Possibility to use current modules with efficiency up to 190lm/W and CRI>90. Available upon request.

#### APPLICATION

- main and decorative lighting

#### MOUNTING

- suspended, using dedicated accessories

#### ADDITIONAL INFORMATION

- when choosing a different length of profiles / covers than available in the standard, you should additionally choose the cutting service at KLUŚ
- NCS Premium paint option - minimum order quantity 30pcs - available on order within 14 days

#### TECHNICAL DRAWING

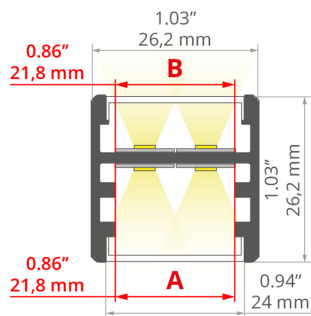

#### TECHNICAL SPECIFICATIONS

|  |   |
|--|---|
| Material                                 | aluminum  |
| Color                                    | ■ silver anodized   |
| Possible fixture IP                      | 20  |
| Possible fixture shapes                  | linear, polygonal   |
| Profile cross-section                    | rectangular   |
| Width                                    | 1"  |
| Height                                   | 1"  |
| LED gluing width A                       | 0.9"  |
| LED gluing width B                       | 0.9"  |
| Number of LED strips A (0.31" wide)      | 2   |
| Number of LED strips B (0.31" wide)      | 2   |
| Width of the glow                        | 22 mm   |
| Max power of a single KLUŚ LED strip     | 7.3 W/ft  |
| Possibility of obtaining a line of light | yes   |
| Building type                            | Entertainment/ Arts, Hotel / Restaurant, Commercial, Retail |
| Facility zone                            | office, lobby / foyer, decorative, media rooms / av         |

|        |           |
|--------|-----------|
| Length | Ref       |
| 39.4"  | A03059A_1 |
| 78.9"  | A03059A_2 |
| 118.5" | A03059A_3 |

# GLAZA-DUO Extrusion

Ref. A03059

|   |     |
|---|-----|
| Can be easily connected into runs               | yes |
| Two directional lighting for suspended fixtures | yes |

## LINE OF LIGHT TABLE

| LED tape        | LIGER-22 satin | HS-22 frosted |
|-----------------|----------------|---------------|
| K-2300-24       | ✓ (2)          | X             |
| K-CR-1220-24    | ✓ (2)          | X             |
| K-CR-1275-24    | ✓ (2)          | X             |
| K-CRHD-1820-24  | ✓ (2)          | ✓ (2)         |
| K-CRHD-1910-24  | ✓ (2)          | ✓ (2)         |
| K-HEHD-0480-24  | ✓ (2)          | ✓ (2)         |
| K-HEHD-0960-24  | ✓ (2)          | ✓ (2)         |
| K-HEHD-1440-24  | ✓ (2)          | ✓ (2)         |
| K-HEHD-1920-24  | ✓ (2)          | ✓ (2)         |
| K-HEHD-0320-24  | ✓ (2)          | ✓ (2)         |
| K-18D30-0960-24 | ✓ (2)          | ✓ (2)         |
| K-27T50-1440-24 | ✓ (2)          | ✓ (2)         |
| K-CRHD-0530-24  | ✓ (2)          | ✓ (2)         |

### Description

- ✓ - Line of Light for a number (X) of rows - Pixel free imaging
- X - Visible Dotting from Diodes
- HL - Centered Line of Light - Concentrated in middle
- HL (X) - Centered Line of Light for a number (X) of rows - Concentrated in middle

### Line of Light Guide

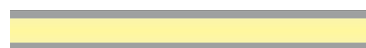

Clean Line of Light (Pixel free imaging)

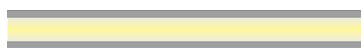

Centered Line of Light







Visible Dotting from Diodes

### SAMPLE PROJECTS



## RELATED ACCESSORIES > COVERS

| NAME   | KEY FEATURES  | MATERIAL | MATERIAL TRANSMITTANCE | COLOR      | REF.    |
|--|---|----------|------------------------|------------|---------|
| BENCO-22 Cover  |  <ul style="list-style-type: none"> <li>- For indoor and outdoor applications</li> <li>- UV resistant</li> </ul> | silicon  | 62 %                   | frosted    | B17209F |
| LIGER-22 Cover  | <ul style="list-style-type: none"> <li>- For indoor and outdoor applications</li> <li>- Ease of obtaining a line of light</li> <li>- perfectly diffusing</li> </ul>                               | PC       | 22 %                   | black      | B17032B |
|  |   |          | 70 %                   | satin      | B17032S |
| HS-22 Cover     | <ul style="list-style-type: none"> <li>- For indoor and outdoor applications</li> <li>- UV resistant</li> </ul>   | PC       | 65 %                   | frosted    | B17011F |
|  |   |          | 88 %                   | clear      | B17011C |
|  |   |          | 90.5 %                 | microprism | B17011M |

## RELATED ACCESSORIES > END CAPS

| NAME   | MATERIAL        | COLOR  | REF.      |
|--|-----------------|--|-----------|
|   | aluminum, PET-G |  silver   | C28141AS  |
| GLAZA-DUO End cap   | ABS             |  gray   | C24418C02 |
|  |                 |  silver | C24418L01 |

## RELATED ACCESSORIES > RELATED LED > RGB / RGB-W / RGB-CTT

| Name                        | Key features        | IP protection rating | Power consumption | Ref.               |
|-----------------------------|---------------------|----------------------|-------------------|--------------------|
| K-RGB27T65-1200-24 LED tape | - RGB+Tunable White | 20                   | 3.7 W/ft          | K-RGB27T65-1200-24 |

## RELATED ACCESSORIES > RELATED LED > HIGH EFFICACY

| Name                    | Key features   | IP protection rating | Power consumption | Ref.             |
|-------------------------|--|----------------------|-------------------|------------------|
| K-HEHD-0480-24 LED tape | <ul style="list-style-type: none"> <li>- CRI over 95</li> <li>- High Efficacy</li> </ul> | 20                   | 1.5 W/ft          | K-HEHD22-0480-24 |
|                         |  |                      |                   | K-HEHD25-0480-24 |
|                         |  |                      |                   | K-HEHD27-0480-24 |
|                         |  |                      |                   | K-HEHD30-0480-24 |
|                         |  |                      |                   | K-HEHD35-0480-24 |
|                         |  |                      |                   | K-HEHD40-0480-24 |
| K-HEHD-0960-24 LED tape | <ul style="list-style-type: none"> <li>- CRI over 95</li> <li>- High Efficacy</li> </ul> | 20                   | 2.9 W/ft          | K-HEHD22-0960-24 |
|                         |  |                      |                   | K-HEHD25-0960-24 |
|                         |  |                      |                   | K-HEHD27-0960-24 |
|                         |  |                      |                   | K-HEHD30-0960-24 |
|                         |  |                      |                   | K-HEHD35-0960-24 |
|                         |  |                      |                   | K-HEHD40-0960-24 |
| K-HEHD50-0960-24        |  |                      |                   |                  |

# GLAZA-DUO Extrusion

Ref. A03059

| Name                    | Key features                     | IP protection rating | Power consumption | Ref.   |
|-------------------------|----------------------------------|----------------------|-------------------|--|
| K-HEHD-1440-24 LED tape | - CRI over 95<br>- High Efficacy | 20                   | 4.4 W/ft          | K-HEHD22-1440-24<br>K-HEHD25-1440-24<br>K-HEHD27-1440-24<br>K-HEHD30-1440-24<br>K-HEHD35-1440-24<br>K-HEHD40-1440-24<br>K-HEHD50-1440-24 |
| LED tape K-HEHD-1920-24 | - CRI over 95<br>- High Efficacy | 20                   | 5.9 W/ft          | K-HEHD22-1920-24<br>K-HEHD25-1920-24<br>K-HEHD27-1920-24<br>K-HEHD30-1920-24<br>K-HEHD35-1920-24<br>K-HEHD40-1920-24<br>K-HEHD50-1920-24 |
| K-HEHD-0320-24 LED tape | - CRI over 95<br>- High Efficacy | 20                   | 1 W/ft            | K-HEHD22-0320-24<br>K-HEHD25-0320-24<br>K-HEHD27-0320-24<br>K-HEHD30-0320-24<br>K-HEHD35-0320-24<br>K-HEHD40-0320-24<br>K-HEHD50-0320-24 |

## RELATED ACCESSORIES > RELATED LED > CRI 95+

| Name                    | Key features                        | IP protection rating | Power consumption | Ref.   |
|-------------------------|-------------------------------------|----------------------|-------------------|--|
| LED tape K-CR-1210-24   | - CRI over 95                       | 20                   | 1.5 W/ft          | K-CR22-1210-24<br>K-CR25-1210-24<br>K-CR27-1210-24<br>K-CR30-1210-24<br>K-CR35-1210-24<br>K-CR40-1210-24<br>K-CR50-1210-24               |
| LED tape K-CR-1220-24   | - CRI over 95                       | 20                   | 2.9 W/ft          | K-CR22-1220-24<br>K-CR25-1220-24<br>K-CR27-1220-24<br>K-CR30-1220-24<br>K-CR35-1220-24<br>K-CR40-1220-24<br>K-CR50-1220-24               |
| LED tape K-CR-1275-24   | - CRI over 95                       | 20                   | 4.4 W/ft          | K-CR22-1275-24<br>K-CR25-1275-24<br>K-CR27-1275-24<br>K-CR30-1275-24<br>K-CR35-1275-24<br>K-CR40-1275-24<br>K-CR50-1275-24               |
| K-CRHD-1820-24 LED tape | - CRI over 95<br>- high LED density | 20                   | 5.6 W/ft          | K-CRHD22-1820-24<br>K-CRHD25-1820-24<br>K-CRHD27-1820-24<br>K-CRHD30-1820-24<br>K-CRHD35-1820-24<br>K-CRHD40-1820-24<br>K-CRHD50-1820-24 |
| K-CRHD-1910-24 LED tape | - CRI over 95<br>- high LED density | 20                   | 2.8 W/ft          | K-CRHD22-1910-24<br>K-CRHD25-1910-24<br>K-CRHD27-1910-24<br>K-CRHD30-1910-24<br>K-CRHD35-1910-24<br>K-CRHD40-1910-24<br>K-CRHD50-1910-24 |

| Name                     | Key features  | IP protection rating | Power consumption | Ref.   |
|--------------------------|---------------|----------------------|-------------------|--|
| K-CRHD-0530-24 LED tape, | - CRI over 95 | 20                   | 1.6 W/ft          | K-CRHD22-0530-24<br>K-CRHD25-0530-24<br>K-CRHD27-0530-24<br>K-CRHD30-0530-24<br>K-CRHD35-0530-24<br>K-CRHD40-0530-24<br>K-CRHD50-0530-24 |

#### RELATED ACCESSORIES > RELATED LED > CRI 90+

| Name               | Key features | IP protection rating | Power consumption | Ref.   |
|--------------------|--------------|----------------------|-------------------|--|
| LED tape K-2400-24 | - high power | 20                   | 7.3 W/ft          | K-27-2400-24<br>K-30-2400-24<br>K-35-2400-24<br>K-40-2400-24<br>K-50-2400-24 |
| LED tape K-2400-24 | - high power | 20                   | 7.3 W/ft          | K-27-2400-24<br>K-30-2400-24<br>K-35-2400-24<br>K-40-2400-24<br>K-50-2400-24 |

#### RELATED ACCESSORIES > RELATED LED

| Name   | IP protection rating | Power consumption | Ref.   |
|--|----------------------|-------------------|--|
| LED tape K-0360-24 1.1 W/m, IP20 <span style="background-color: red; color: white; padding: 2px;">NEW</span> | 20                   | 1.1 W/ft          | K-27-0360-24<br>K-30-0360-24<br>K-35-0360-24<br>K-40-0360-24<br>K-50-0360-24 |
| LED tape K-2300-24   | 20                   | 7 W/ft            | K-30-2300-24<br>K-40-2300-24   |
| LED tape K-18D30-0960-24   | 20                   | 2.9 W/ft          | K-18D30-0960-24  |
| LED tape K-27T50-1440-24   | 20                   | 4.4 W/ft          | K-27T50-1440-24  |

#### RELATED ACCESSORIES > OTHER ACCESSORIES > EXTRUSION MASKING COVERS

| Name                | Key features | Material | Color   | Ref.  |
|---------------------|--------------|----------|---|---|
| MP-22 Masking cover | - Lightproof | PC       | <div style="display: flex; flex-direction: column; gap: 5px;"> <div><span style="display: inline-block; width: 10px; height: 10px; background-color: #ccc; border: 1px solid #000;"></span> gray metalized</div> <div><span style="display: inline-block; width: 10px; height: 10px; background-color: #999; border: 1px solid #000;"></span> gray metalized</div> <div><span style="display: inline-block; width: 10px; height: 10px; background-color: #fff; border: 1px solid #000;"></span> white lacquered</div> <div><span style="display: inline-block; width: 10px; height: 10px; background-color: #fff; border: 1px solid #000;"></span> white lacquered</div> <div><span style="display: inline-block; width: 10px; height: 10px; background-color: #000; border: 1px solid #000;"></span> black lacquered</div> <div><span style="display: inline-block; width: 10px; height: 10px; background-color: #000; border: 1px solid #000;"></span> black lacquered</div> </div> | C28261L01_1<br>C28261L01_0.25<br>C28261L10_1<br>C28261L10_0.25<br>C28261L07_1<br>C28261L07_0.25 |

#### RELATED ACCESSORIES > OTHER ACCESSORIES > CANOPIES

| Name           | Key features   | Material | Color   | Ref.                                |
|----------------|--|----------|---|-------------------------------------|
| Fi-60mm Canopy | - Convenient cable length adjustment, in the ZM system | steel    | <div style="display: flex; flex-direction: column; gap: 5px;"> <div><span style="display: inline-block; width: 10px; height: 10px; background-color: #ccc; border: 1px solid #000;"></span> gray lacquered</div> <div><span style="display: inline-block; width: 10px; height: 10px; background-color: #fff; border: 1px solid #000;"></span> white lacquered</div> <div><span style="display: inline-block; width: 10px; height: 10px; background-color: #000; border: 1px solid #000;"></span> black lacquered</div> </div> | C24540L01<br>C24540L10<br>C24540L07 |

#### RELATED ACCESSORIES > OTHER ACCESSORIES > CONDUCTIVE FASTENERS AND HEADS FOR EXTRUSIONS

# GLAZA-DUO Extrusion

Ref. A03059

| Name                     | Key features                    | Material            | Color   | Ref.      |
|--------------------------|---------------------------------|---------------------|---------|-----------|
| OS22-LIN-Z Fastener      | - Power supply cable            | stainless steel, PA | ☐ white | C28184L10 |
|                          |                                 |                     | ■ black | C28184L07 |
| OS22-PRET-Z Fastener     | - Power supply rod              | PA, stainless steel | ☐ white | C28186L10 |
|                          |                                 |                     | ■ black | C28186L07 |
| OS22-DUO-LIN-Z Fastener  | - Power supply cable, two poles | stainless steel, PA | ☐ white | C28183L10 |
|                          |                                 |                     | ■ black | C28183L07 |
| OS22-DUO-PRET-Z Fastener | - Power supply cable, two poles | stainless steel, PA | ☐ white | C28185L10 |
|                          |                                 |                     | ■ black | C28185L07 |

## RELATED ACCESSORIES > OTHER ACCESSORIES > ADDITIONAL ITEMS

| Name        | Material | Ref.      |
|-------------|----------|-----------|
| 8x1,6 Gland | rubber   | C42290C07 |
| M8x1 Gland  | brass    | C42265N00 |

## RELATED ACCESSORIES > OTHER ACCESSORIES > CONNECTORS

| Name              | Material        | Color    | Ref.      |
|-------------------|-----------------|----------|-----------|
| ZM Connector      | stainless steel | ■ silver | 42716     |
|                   |                 |          | 42717     |
|                   |                 |          | 42720     |
|                   |                 |          | 42728     |
|                   |                 |          | C28070N00 |
|                   |                 |          | C28071N00 |
|                   |                 |          | C28072N00 |
|                   |                 |          | C28073N00 |
|                   |                 |          | C28074N00 |
|                   |                 |          | C28075N00 |
| C28243N00         |                 |          |           |
| ZM-PION Connector | stainless steel | ■ silver | 42314     |
|                   |                 |          | 42316     |
|                   |                 |          | 42320     |
|                   |                 |          | 42718     |
|                   |                 |          | 42719     |
|                   |                 |          | C28084N00 |
|                   |                 |          | C28085N00 |
|                   |                 |          | C28086N00 |
| C28087N00         |                 |          |           |
| C28088N00         |                 |          |           |

## RELATED ACCESSORIES > ELECTRONICS > SWITCHES

| Name                 | Key features                           | IP protection rating | Ref.   |
|----------------------|--|----------------------|--------|
| Proximity switch UNI | - touchless switch<br>- width only 7mm | 20                   | E61579 |